

CRS-500

500W SINGLE OUTPUT DC/DC CONVERTERS

GENERAL FEATURES:

- Designed according to EN50155
- Fire and smoke: EN45545-2 approved
- High input-output isolation
- Adjustable output voltage
- Remote inhibit
- Remote sensing
- Input & Output OK LEDs
- Output failure alarm
- Input reverse polarity protection
- ORing FET option
- Efficiency up to 92%



	24Vin 14,4V ... 30V	36Vin 21,6V ... 47V	48Vin 28,8V ... 60V	72Vin 43,2V ... 90V	110Vin 66V ... 144V
24Vout	CRS-500-6455	CRS-500-6467	CRS-500-6458	CRS-500-6461	CRS-500-6464
48Vout	CRS-500-6456	CRS-500-6468	CRS-500-6459	CRS-500-6462	CRS-500-6465
110Vout	CRS-500-6457	-	-	-	-



INPUT	
Input voltage range	See table
Input undervoltage shutdown	55% to 60% Vi nom
Maximum allowed input ripple	15% Vin nom (EN50155)
OUTPUT	
Output voltage	See table
Output voltage adjustment	
Vi min = 60% Vi nom	-10% ... +0% Vo nom
Vi min = 70% Vi nom	-10% ... +15% Vo nom
Line regulation (Io = nom)	< 0,2 %
Load regulation (Vin = nom Io: 0...100%)	< 0,2 %, 2.5 % for ORing FET option
Ripple	< 50 mVpp
Noise (BW = 20MHz)	< 100 mVpp
Max. overvoltage protection	< 140% Vout nom
Maximum remote sense	0.3V / pole
ENVIRONMENTAL	
Storage temperature	-40°C ... 85°C
Operating temperature range Io: 100%	-25°C ... 55°C(-40°C ... 55°C, see note-1)
Operating temperature range Io :75%	-25°C ... 70°C(-40°C ... 70°C, see note-1)
Cooling	Natural convection
Maximum Relative humidity	95% with no condensation
Shock and vibration	EN61373 Category 1 class B body mounted
MTBF	400.000h @ 40°C according to IEC61709
EMC	
Emission	EN61000-6-4, EN50121-3-2
Immunity	EN61000-6-2, EN50121-3-2
SAFETY	
Safety	EN60950-1, EN62368-1
Dielectric strength Input-Output	3000Vac, 4200Vdc 1min.
Dielectric strength Input-Earth	1500Vac, 2100Vdc 1min.
Dielectric strength Output-Earth	1500Vac, 2100Vdc 1min.
Fire and smoke	EN45545-2:2013 +A1:2015
MECHANICAL	
Approximate weight	1800g
CONTROL	
Remote inhibit range	16.8 ... 143 Vdc
Alarm contacts	1A @ 24Vdc, 0.3A @ 150Vdc, 1A @ 125Vac
Local: Input OK, Output OK	Green LEDs
PROTECTIONS	
Against overloads and short-circuits	Current limiting
Against output over-voltages	Shutdown (reset by input switch off)
Against reverse input voltage.	Input fuse (Active protection with option H)
Against input under-voltage.	Under-voltage lock-out
Against Input over-currents	Input fuse

Note-1: The unit can start up and work at an ambient temperature of -40°C with the following restrictions:
1) Do not handle the connection terminals below -25°C. 2) The output ripple can rise up to 150mVpp at -40°C



ORDERING CODES

PartNumber	Power [W]	Input [V]	Input range [V]	Output [V]	Output current [A]	Efficiency [%]
CRS-500-6455	500	24	14,4-30	24	20,8	88
CRS-500-6456	500	24	14,4-30	48	10,4	89
CRS-500-6457	500	24	14,4-30	110	4,54	90
CRS-500-6467	500	36	21,6-47	24	20,8	90
CRS-500-6468	500	36	21,6-47	48	10,4	90
CRS-500-6458	500	48	28,8-60	24	20,8	91
CRS-500-6459	500	48	28,8-60	48	10,4	91
CRS-500-6461	500	72	43,2-90	24	20,8	91
CRS-500-6462	500	72	43,2-90	48	10,4	91
CRS-500-6464	500	110	66-144	24	20,8	91
CRS-500-6465	500	110	66-144	48	10,4	92

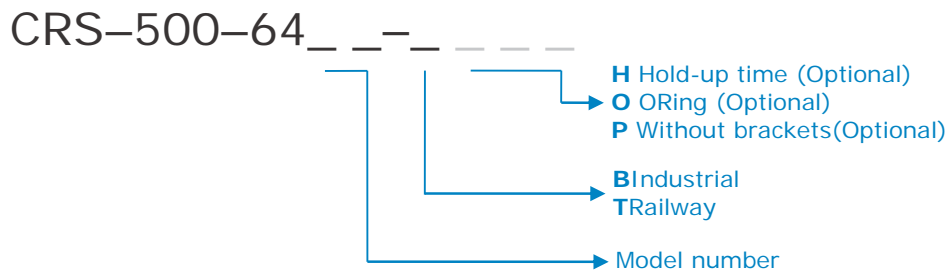

OPTIONS INFORMATION	Letter code
Industrial version	B
Railway version	T
Hold up time of 10ms at 500W and Vin nom for all models except the 24Vin, which power is 440W. Includes: <ul style="list-style-type: none"> • Active protection against input reverse polarity • Active inrush current limiter at < 3·I(input nominal) 	H
Oring FET for redundancy. Includes a passive current sharing by voltage drop < 2.5%	O
Case without mounting brackets for 6U subrack fitting or DIN rail	P

Accessories must be ordered in a separated order line



BLOCKS DIAGRAM

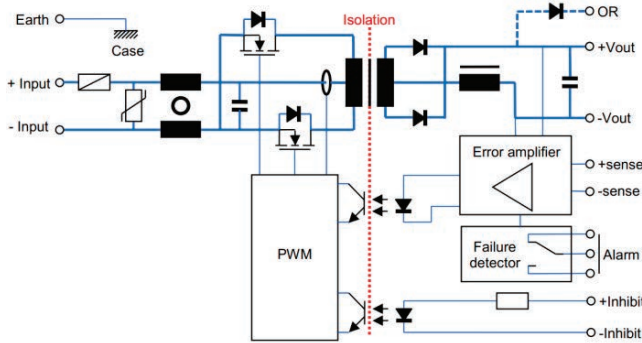

CONNECTIONS



Power connections (input and output)

Spring clamp terminals up to 16mm²

Signals connector

1	+ Inhibit
2	- Inhibit
3	- Remote sense
4	+ Remote sense
5	Alarm relay NC (closed when alarm)
6	Alarm relay Common
7	Alarm relay NO (open when alarm)

TYPICAL OUTPUT CHARACTERISTIC

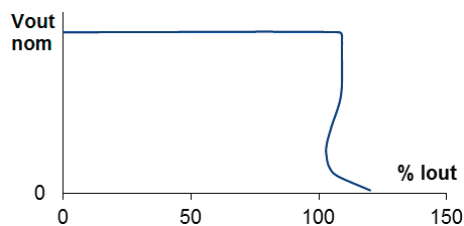

POWER DERATING vs AMBIENT TEMP.

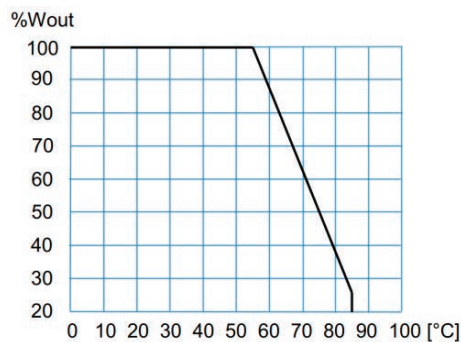

DESCRIPTION

The CRS-500 series consists of DC-DC converters with a galvanic isolation between input and output. The converters operate at a fixed switching frequency and use push-pull converter topology.

For maximum regulation, the remote sensing terminals can be connected to the load. This will allow a power cable voltage drop of up to 0.3 V on each cable to be offset.

The device is protected against overloads and short-circuits by means of a current limiting circuit.

The device is also protected against reverse polarity input voltage, and the input fuse blows if an improper connection is made.

When a converter input undervoltage condition occurs, the converter is disabled, thus preventing the battery from becoming totally discharged.

INSTALLATION

The product can be mounted in several ways:

- On a chassis by means of the mounting brackets holes.
- On a DIN rail adding two clip accessories NP-9135.

Into a 6U subrack adding the accessory NP-9222

START-UP

Perform connection according to the figure. Use of remote sensing is not mandatory, but if this is required, use of a coaxial or a twisted-pair cable is recommended.

WARNING: If the load is connected to the tabs of remote sensing (+/-S) and the connection from the output to this load is missing the remote sensing function could make unusable due to the acting of the internal fuse of protection.

If power levels close to the maximum output are required, make sure the assembly enhances cooling by natural convection and the unit is placed in vertical position.

If several converters need to be connected in parallel, do the following:

- Set the output voltage for all converters featuring a mutual difference as small as possible.
- Join the load outputs by using cables with a cross-section no greater than the one required and of equal length.
- Do not use remote sensing.

For safety reasons, the following requirements must be complied with:

- Provide the equipment with a protective enclosure that complies with the electrical safety directives in effect within the country where the equipment is installed.
- Only replace the fuse with another fuse of the same rating and type, and only after disconnecting the converter from DC power.



DIMENSIONS

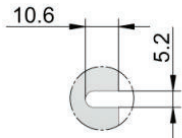
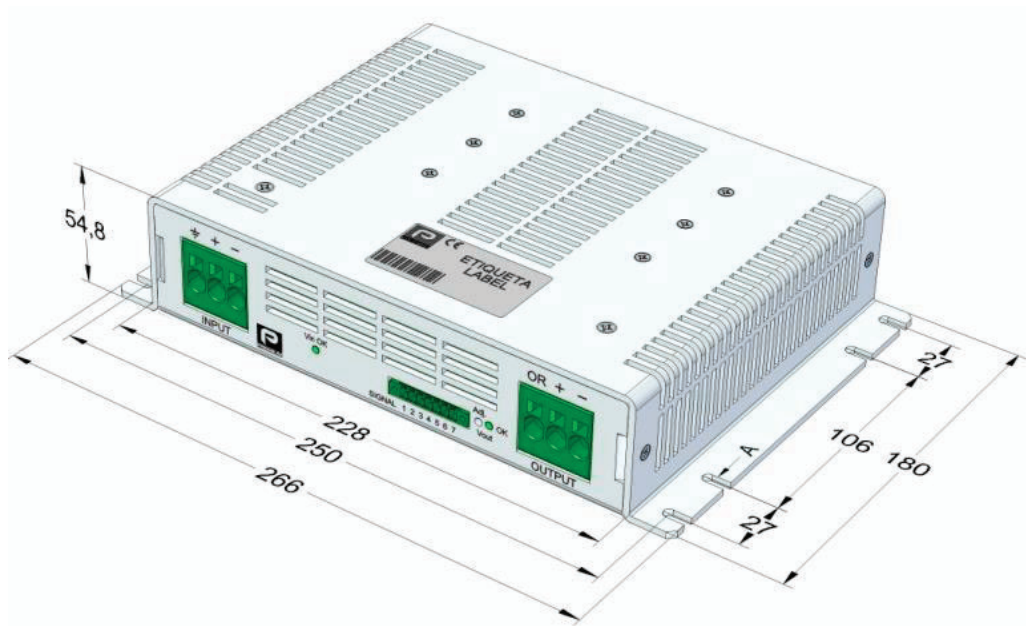

ACCESSORIES

ACCESSORIES	Notes	Order qty. / device	CODE
Signals mating connector	Phoenix Contact FK-MCP 1,5/ 7-STF-3,81	1	2601-395
DIN RAIL CLIP	Screws included	2	NP-9135
Subrack guiding plates	Screws included	1	NP-9222
2U 19" rackmount tray kit	Screws included	1	NP-9354

2601-395



NP-9135



Option P + 2xNP-9135





Option P + 1xNP-9222

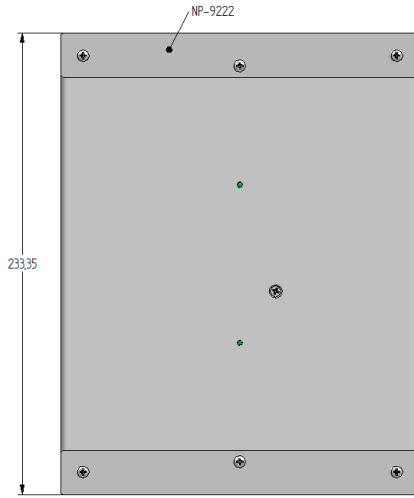
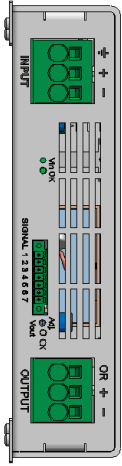

NP-9354

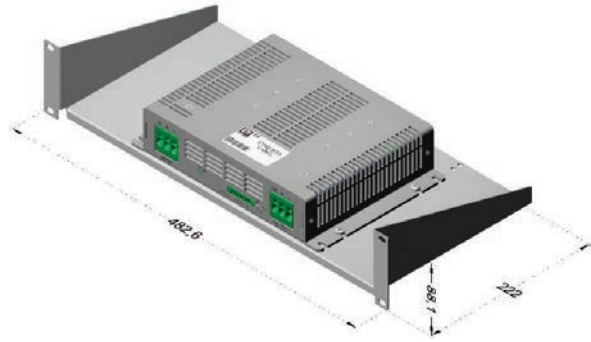



CE EU DECLARATION OF CONFORMITY

The undersigned, representing the following:

Manufacturer: PREMIUM, S. A.,
Address: C/ Dolors Aleu 19-21, 08908 L'Hospitalet de Llobregat, SPAIN

herewith declares that the product:

Type: DC/DC converter
Models: **CRS-500-6455... 6475**

is in conformity with the provisions of the following EU directive(s):

2014/35/EU	Low voltage
2014/30/EU	Electromagnetic compatibility
2011/65/EU	Restriction of the use of certain hazardous substances in electrical and electronic equipment (RoHS)

and that standards and/or technical specifications referenced overleaf have been applied:

EN 60950-1: 2005	Safety. Information technology equipment
EN 62368-1: 2014	Safety. Audio/video, information and communication technology equipment
EN 61000-6-4: 2007	Generic emission standard
EN 61000-6-2: 2005	Generic immunity standard
EN 50155: 2017*	Railway applications. Electronic equipment used on rolling stock material
EN 50121-3-2: 2016*	Railway applications. EMC Rolling stock equipment
EN 50121-4: 2016*	Railway applications. EMC of the signalling and telecommunications apparatus

* Optional, See annexe

CE marking year: **2009**

Notes:

For the fulfillment of this declaration the product must be used only for the aim that has been conceived, considering the limitations established in the instructions manual or datasheet.

L'Hospitalet de Llobregat, 28-08-2019

Jordi Gazo
Chief Executive Officer

PREMIUM S.A. is an ISO9001 and ISO14001
certified company by **Bureau Veritas**



ANNEXE

Applicable values for the different sections of the norm EN50155: 2017

4.3.1	Working altitude	Up to 2000m																																																																				
4.3.2	Ambient temperature	Class OT1 (-25 to 55°C): load < 100% Class OT2 (-40 to 55°C): load < 100% (Without connectors handling and output ripple <150mVpp) Class OT3 (-25 to 70°C): load < 75% Class OT4 (-40 to 70°C): load < 75% (Without Connectors handling and output ripple <150mVpp) Class OT5 (-25 to 85°C): load < 37.5% Class OT6 (-40 to 85°C): load < 37.5% (Without Connectors handling and output ripple <150mVpp)																																																																				
4.3.3	Switch-on extended operating temp.	ST1																																																																				
4.3.4	Rapid temperature variations	H1																																																																				
4.3.5	Shocks and vibrations	According EN61373:2010 Category 1 class B																																																																				
4.3.6	EMC Electromagnetic Compatibility EN50121-3-2:2016 EN50121-4:2016	<table border="1"> <thead> <tr> <th>Test</th> <th>Norm</th> <th>Port</th> <th>Frequency</th> <th>Limits</th> </tr> </thead> <tbody> <tr> <td rowspan="3">Radiated emissions</td> <td rowspan="3">IEC55016</td> <td rowspan="3">Case</td> <td>30MHz...230MHz</td> <td>40dB(µV/m) Qpk at 10m</td> </tr> <tr> <td>230MHz...1GHz</td> <td>47dB(µV/m) Qpk at 10m</td> </tr> <tr> <td>1...3GHz</td> <td>Do not apply</td> </tr> <tr> <td rowspan="2">Conducted emissions</td> <td rowspan="2">IEC55016</td> <td rowspan="2">Input</td> <td>3...6GHz</td> <td>Internal freq. < 108MHz</td> </tr> <tr> <td>150kHz...500kHz</td> <td>79dB(µV) Qpk, 66dB(µV) Av</td> </tr> <tr> <td></td> <td></td> <td></td> <td>500kHz...30MHz</td> <td>79dB(µV) Qpk, 60dB(µV) Av</td> </tr> </tbody> </table>			Test	Norm	Port	Frequency	Limits	Radiated emissions	IEC55016	Case	30MHz...230MHz	40dB(µV/m) Qpk at 10m	230MHz...1GHz	47dB(µV/m) Qpk at 10m	1...3GHz	Do not apply	Conducted emissions	IEC55016	Input	3...6GHz	Internal freq. < 108MHz	150kHz...500kHz	79dB(µV) Qpk, 66dB(µV) Av				500kHz...30MHz	79dB(µV) Qpk, 60dB(µV) Av																																								
		Test	Norm	Port	Frequency	Limits																																																																
		Radiated emissions	IEC55016	Case	30MHz...230MHz	40dB(µV/m) Qpk at 10m																																																																
					230MHz...1GHz	47dB(µV/m) Qpk at 10m																																																																
					1...3GHz	Do not apply																																																																
		Conducted emissions	IEC55016	Input	3...6GHz	Internal freq. < 108MHz																																																																
					150kHz...500kHz	79dB(µV) Qpk, 66dB(µV) Av																																																																
					500kHz...30MHz	79dB(µV) Qpk, 60dB(µV) Av																																																																
		<table border="1"> <thead> <tr> <th>Test</th> <th>Norm</th> <th>Port</th> <th>Severity</th> <th>Conditions</th> <th>P</th> </tr> </thead> <tbody> <tr> <td rowspan="2">Electrostatic discharge</td> <td rowspan="2">IEC61000-4-2</td> <td rowspan="2">Case</td> <td>±8kV</td> <td>Air (isolated parts)</td> <td rowspan="2">B</td> </tr> <tr> <td>±8kV</td> <td>Contact (conductive parts)</td> </tr> <tr> <td rowspan="4">Radiated high-frequency</td> <td rowspan="4">IEC61000-4-3</td> <td rowspan="4">X/Y/Z Axis</td> <td>20V/m</td> <td>0.08...1.0GHz M. 80% 1kHz</td> <td rowspan="4">A</td> </tr> <tr> <td>10V/m</td> <td>1.4...2.1GHz M. 80% 1kHz</td> </tr> <tr> <td>5V/m</td> <td>2.1...2.5GHz M. 80% 1kHz</td> </tr> <tr> <td>3V/m</td> <td>5.1...6GHz M. 80% 1kHz</td> </tr> <tr> <td rowspan="4">Fast transients</td> <td rowspan="4">IEC61000-4-4</td> <td>Input</td> <td>±2kV</td> <td rowspan="4">Tr/Th: 5/50 ns</td> <td rowspan="4">A</td> </tr> <tr> <td>Output</td> <td>±2kV</td> </tr> <tr> <td>Signal</td> <td>±2kV</td> </tr> <tr> <td>PE</td> <td>±1kV</td> </tr> <tr> <td rowspan="2">Surge</td> <td rowspan="2">IEC61000-4-5</td> <td>Input L to L</td> <td>±1kV</td> <td rowspan="2">Tr/Th: 1.2/50µs</td> <td rowspan="2">B</td> </tr> <tr> <td>Input L to PE</td> <td>±2kV</td> </tr> <tr> <td rowspan="4">Conducted RF</td> <td rowspan="4">IEC61000-4-6</td> <td>Input</td> <td>10V</td> <td rowspan="4">0.15...80MHz M. 80% 1kHz</td> <td rowspan="4">A</td> </tr> <tr> <td>Output</td> <td>10V</td> </tr> <tr> <td>Signal</td> <td>10V</td> </tr> <tr> <td>PE</td> <td>10V</td> </tr> <tr> <td>Magnetic field</td> <td>IEC61000-4-8</td> <td>X/Y/Z Axis</td> <td>300A/m</td> <td>0Hz, 16.7Hz, 50/60Hz</td> <td>A</td> </tr> </tbody> </table>					Test	Norm	Port	Severity	Conditions	P	Electrostatic discharge	IEC61000-4-2	Case	±8kV	Air (isolated parts)	B	±8kV	Contact (conductive parts)	Radiated high-frequency	IEC61000-4-3	X/Y/Z Axis	20V/m	0.08...1.0GHz M. 80% 1kHz	A	10V/m	1.4...2.1GHz M. 80% 1kHz	5V/m	2.1...2.5GHz M. 80% 1kHz	3V/m	5.1...6GHz M. 80% 1kHz	Fast transients	IEC61000-4-4	Input	±2kV	Tr/Th: 5/50 ns	A	Output	±2kV	Signal	±2kV	PE	±1kV	Surge	IEC61000-4-5	Input L to L	±1kV	Tr/Th: 1.2/50µs	B	Input L to PE	±2kV	Conducted RF	IEC61000-4-6	Input	10V	0.15...80MHz M. 80% 1kHz	A	Output	10V	Signal	10V	PE	10V	Magnetic field	IEC61000-4-8	X/Y/Z Axis	300A/m	0Hz, 16.7Hz, 50/60Hz	A
		Test	Norm	Port	Severity	Conditions	P																																																															
		Electrostatic discharge	IEC61000-4-2	Case	±8kV	Air (isolated parts)	B																																																															
					±8kV	Contact (conductive parts)																																																																
		Radiated high-frequency	IEC61000-4-3	X/Y/Z Axis	20V/m	0.08...1.0GHz M. 80% 1kHz	A																																																															
					10V/m	1.4...2.1GHz M. 80% 1kHz																																																																
5V/m	2.1...2.5GHz M. 80% 1kHz																																																																					
3V/m	5.1...6GHz M. 80% 1kHz																																																																					
Fast transients	IEC61000-4-4	Input	±2kV	Tr/Th: 5/50 ns	A																																																																	
		Output	±2kV																																																																			
		Signal	±2kV																																																																			
		PE	±1kV																																																																			
Surge	IEC61000-4-5	Input L to L	±1kV	Tr/Th: 1.2/50µs	B																																																																	
		Input L to PE	±2kV																																																																			
Conducted RF	IEC61000-4-6	Input	10V	0.15...80MHz M. 80% 1kHz	A																																																																	
		Output	10V																																																																			
		Signal	10V																																																																			
		PE	10V																																																																			
Magnetic field	IEC61000-4-8	X/Y/Z Axis	300A/m	0Hz, 16.7Hz, 50/60Hz	A																																																																	
P= Performance criteria, L= Line, PE= Protective Earth																																																																						
4.3.7	Relative humidity	Up to 95%																																																																				
5.1.1.2	DC power supply range	From 0.70 to 1.25 Un continuous																																																																				
5.1.1.3	Temporary DC power supply fluctuation	From 0.60 to 1.40 Un 0.1s From 1.25 to 1.40 Un 1s without damage																																																																				
5.1.1.4	Interruptions of voltage supply	Class S1 (without interruptions)																																																																				
5.1.1.6	Input ripple factor	10% peak to peak with a DC Ripple Factor of 5 %																																																																				
5.1.3	Supply change-over	0,6 Un duration 100 ms (without interruptions). Performance criterion A																																																																				
7.2.7	Input reverse polarity protection	By fuse																																																																				
10.7	Protective coating for PCB assemblies	Class PC2																																																																				
13.3	Tests list	1 Visual Inspection 2 Performance test 3 Power supply test 4 Insulation test 5 Low temperature storage test 6 Low temperature start-up test 7 Dry heat test 8 Cyclic damp heat test 9 Salt mist test 10 Enclosure protection test (IP code) 11 EMC test 12 Shocks and vibrations test 13 Equipment stress screening test 14 Rapid Temperature variation test	Routine Routine Routine Routine - Type Type Type - - Type Type Routine: 24h at 40°C and load 100% Type																																																																			

