

# CVS-280

## 280W SINGLE OUTPUT DC/DC CONVERTERS

### GENERAL FEATURES:

- Designed according to EN50155:2017
- Input voltage according EN50163:2006
- Fire and smoke: EN45545-2 pending
- High input-output isolation 7 kVrms
- Output ORing diode
- Input voltage OK LED
- Output voltage OK LED
- Overtemperature shutdown

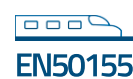

Model	Nominal input voltages	Nominal output voltage
CVS-280-6973	600 / 750 V	24 V
CVS-280-6974	600 / 750 V	36 V
CVS-280-6976	600 / 750 V	72 V
CVS-280-6977	600 / 750 V	110 V



<b>INPUT</b>	
Nominal DC input voltage	600 / 750 V according to EN50163:2006
Minimum DC input voltage	400 V
Maximum DC input voltage	1100 V continuous 3 kV falling to 1.5 kV for 20 ms, 4.5 kV falling to 2.25 kV for 1 ms
Maximum input current	0.84 A
Input consumption at no load	≤ 7 W @ 600 V <sub>in</sub> , ≤ 9 W @ 750 V <sub>in</sub>
Input undervoltage shutdown	45 % to 55 % V <sub>i nom</sub>
<b>OUTPUT</b>	
Output voltage	See previous table
Voltage tolerance	≤ ±1 %
Maximum peak current (I <sub>opk</sub> ) time	500 ms
Total regulation	< ±1 %
Ripple	< 60 mVpp
Ripple + noise (BW 20 MHz)	≤ 1% of nominal output voltage
Maximum continuous power	280 W
Peak power	400 W
<b>ENVIRONMENTAL</b>	
Storage temperature	-40 ... 85 °C
Operating temperature range at I <sub>o</sub> = 100%	-40 ... 70 °C
Operating temperature range at I <sub>o</sub> = 62.5%	-40 ... 85 °C
Cooling	Natural convection
Operating altitude	2500 m
Maximum Relative humidity	95 % with no condensation
Shock and vibration	EN61373:2010 Category 1 class B body mounted
Service life	> 20 years
MTBF	200.000 h @ 40 °C according to IEC61709
<b>EMC</b>	
Emission	EN50121-3-2:2016
Immunity	EN50121-3-2:2016
<b>SAFETY</b>	
Safety according to norm	EN50124-1:2016 Railway app. (Insulation coordination)
Dielectric strength Input / Output	7000 Vac 50 Hz 10 s
Dielectric strength Input / Earth	5300 Vac 50 Hz 10 s
Dielectric strength Output / Earth	1800 Vac 50 Hz 1 min
Protection Degree	IP20
Fire and smoke	EN45545-2:2013 +A1:2015
<b>MECHANICAL</b>	
Dimensions	65 x 162 x 230 mm
Weight	1750 g
<b>CONTROL</b>	
Low output voltage alarm	Threshold: 0.9 ... 0.95 V <sub>o nom</sub> . Isolated solid state relay open when alarm. Maximum rating contact capacity 100 mA and 160 V (closed < 8 Ω)
Remote inhibit input	Inhibit voltage range: Nominal Output Voltage ± 40 %
<b>PROTECTIONS</b>	
Against output overloads and short-circuits	Current limiting
Against reverse input voltage	By input diode in serial connection.
Against input under-voltage	Under-voltage lock-out. See Note 2
Against Input over-currents	Input fuse
Against Overtemperature	Shutdown when internal temperature rises 120 °C
Others	PCB conformal coated with acrylic varnish

Note-1: The unit can start up and work at an ambient temperature of -40°C with the following restrictions:

- Do not handle the connection terminals below -25°C
- The output ripple can rise up to 240mVpp at -40°C

Note-2: In case of lock-out, a pulse of inhibit signal is needed to reset the converter (minimum 100ms); or remove the input supply voltage for at least 3 seconds.



## ORDERING CODES

Model	Nominal Input Voltages [V]	Input Voltage Range [V]	Nominal Output Voltage [V]	Max Output Current [A]	Max Output Power [W]	Output Peak Current [A]	Output Peak Power [W]	Efficiency @750V <sub>in</sub> [%]
<b>CVS-280-6973</b>	600 / 750	400 - 1100	24	11.6	280	16.6	400	88
<b>CVS-280-6974</b>	600 / 750	400 - 1100	36	7.7	280	11.1	400	88
<b>CVS-280-6976</b>	600 / 750	400 - 1100	72	3.8	280	5.67	400	89
<b>CVS-280-6977</b>	600 / 750	400 - 1100	110	2.5	280	3.64	400	89.5

Accessories must be ordered in a separate order line



## BLOCKS DIAGRAM

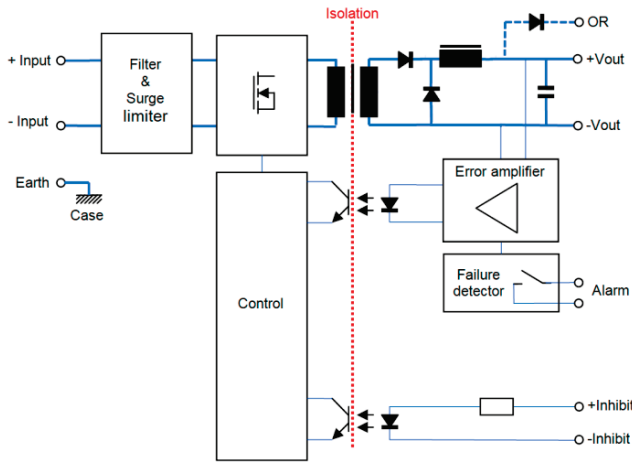

## DESCRIPTION

The CVS-280 series consists of DC/DC converters, with a galvanic isolation between input and output, operating at fixed switching frequency.

It includes an output ORing diode which allows redundancy. It also allows paralleling with a battery.

The device is protected against overload and short-circuits by means of a current limiting circuit.

The device is also protected against reverse polarity input voltage by means of an input diode in series with the input line.

When an input undervoltage condition occurs, the converter is disabled, thus preventing an improper output voltage.

The failure output voltage detector circuit close the contact (NO) when the output voltage is higher than 90..95 % of the nominal output voltage.

## CONNECTIONS

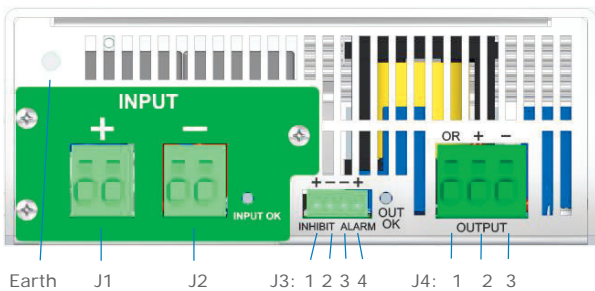

**Note 1:** maximum spring terminals cross section cable 6mm<sup>2</sup> or 10 mm<sup>2</sup> for solid

**Note 2:** J3 recommended female connector Phoenix Contact FMC 1,5/4-ST-3,81 or MC 1,5/4-ST-3,81

**Note 3:** maximum nut torque in M5 earth connection 1.9 Nm

	Function
Earth	M5 male earth connection
J1	Positive input clamp terminal (x2)
J2	Negative input clamp terminal (x2)
J3-1	Positive input inhibit signal
J3-2	Negative input inhibit signal
J3-3	Alarm output state contact 1
J3-4	Alarm output state contact 2
J4-1	Positive output clamp terminal by Oring
J4-2	Positive output clamp terminal
J4-3	Negative output clamp terminal

## TYPICAL OUTPUT CHARACTERISTIC

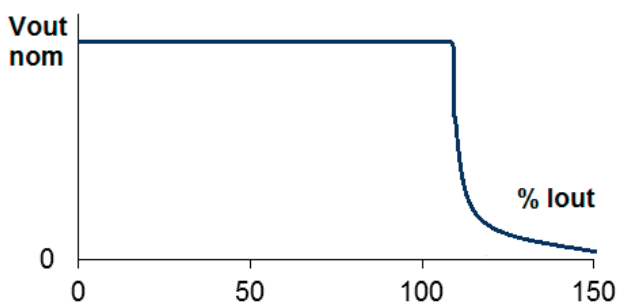

## POWER DERATING vs AMBIENT TEMP.

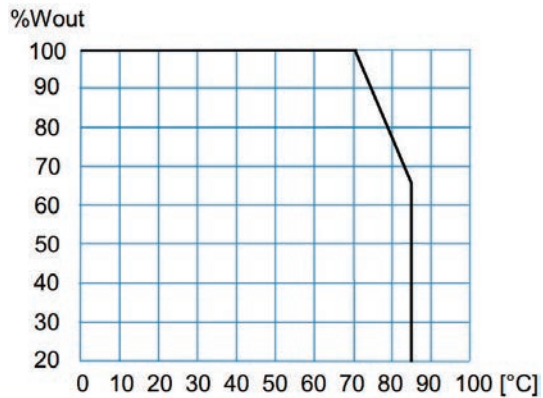



**DIMENSIONS**

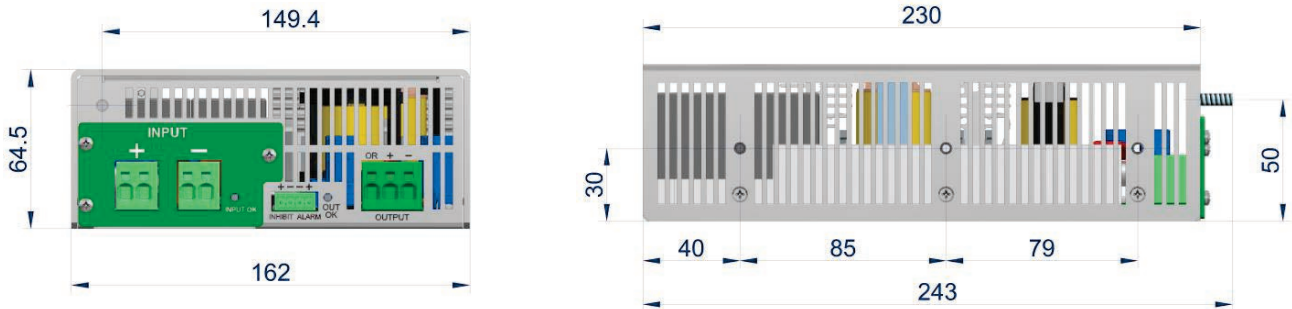

Lateral fixing holes 6 x M4 (screw torque < 1.6 Nm). Maximum screw deep 6 mm.

**ACCESSORIES**

DESCRIPTION	NOTES	CODE
Mounting brackets kit	Contains two brackets and screws	NP-9435

NP-9435

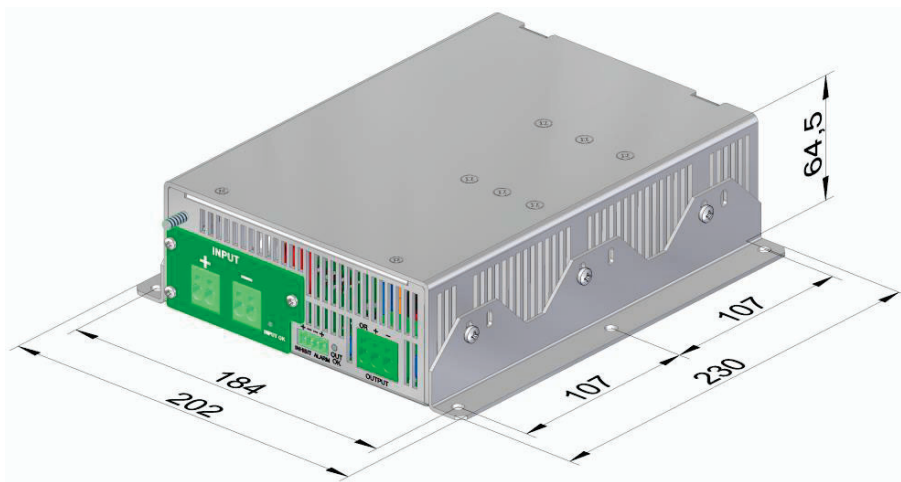



## CE EU DECLARATION OF CONFORMITY

The undersigned, representing the following:

Manufacturer: PREMIUM, S. A.,  
Address: C/ Dolors Aleu 19-21, 08908 L'Hospitalet de Llobregat, SPAIN

herewith declares that the product:

Type: DC/DC converter  
Models: **CVS-280-6973 ... 6977**

is in conformity with the provisions of the following EU directive(s):

2014/35/EU	Low voltage
2014/30/EU	Electromagnetic compatibility
2011/65/EU	Restriction of the use of certain hazardous substances in electrical and electronic equipment (RoHS)

and that standards and/or technical specifications referenced overleaf have been applied:

EN 60950-1: 2005	Safety. Information technology equipment
EN 62368-1: 2014	Safety. <b>Audio/video, information and communication technology equipment</b>
EN 61000-6-3: 2007	Generic emission standard
EN 61000-6-2: 2005	Generic immunity standard
EN 50155: 2017*	Railway applications. Electronic equipment used on rolling stock material
EN 50121-3-2: 2016*	Railway applications. EMC Rolling stock equipment
EN 50121-4: 2016*	Railway applications. EMC of the signalling and telecommunications apparatus

\* See annexe

CE marking year: **2020**

### Notes:

For the fulfillment of this declaration the product must be used only for the aim that has been conceived, considering the limitations established in the instructions manual or datasheet.

L'Hospitalet de Llobregat, 15-05-2020

Jordi Gazo  
Chief Executive Officer

PREMIUM S.A. is an ISO9001 and ISO14001  
certified company by **Bureau Veritas**



## ANNEXE

Applicable values for the different sections of the norm EN50155: 2017																																																																						
4.3.1	Working altitude	Up to 2500m																																																																				
4.3.2	Ambient temperature	Class OT4: load < 100% Class OT6: load < 62.5%																																																																				
4.3.3	Switch-on extended operating temp.	Class ST1, ST2																																																																				
4.3.4	Rapid temperature variations	Class H1																																																																				
4.3.5	Shocks and vibrations	According EN61373:2010 Category 1 class B																																																																				
4.3.6	EMC Electromagnetic Compatibility EN50121-3-2:2015	<table border="1"> <thead> <tr> <th>Test</th> <th>Norm</th> <th>Port</th> <th>Frequency</th> <th>Limits</th> </tr> </thead> <tbody> <tr> <td rowspan="4">Radiated emissions</td> <td rowspan="4">IEC55016</td> <td rowspan="4">Case</td> <td>30MHz...230MHz</td> <td>40dB(μV/m) Qpk at 10m</td> </tr> <tr> <td>230MHz...1GHz</td> <td>47dB(μV/m) Qpk at 10m</td> </tr> <tr> <td>1...3GHz</td> <td>Do not apply</td> </tr> <tr> <td>3...6GHz</td> <td>Internal freq. &lt; 108MHz</td> </tr> <tr> <td rowspan="2">Conducted emissions</td> <td rowspan="2">IEC55016</td> <td rowspan="2">Output</td> <td>150kHz...500kHz</td> <td>99dB(μV) Qpk</td> </tr> <tr> <td>500kHz...30MHz</td> <td>93dB(μV) Qpk</td> </tr> </tbody> </table>	Test	Norm	Port	Frequency	Limits	Radiated emissions	IEC55016	Case	30MHz...230MHz	40dB(μV/m) Qpk at 10m	230MHz...1GHz	47dB(μV/m) Qpk at 10m	1...3GHz	Do not apply	3...6GHz	Internal freq. < 108MHz	Conducted emissions	IEC55016	Output	150kHz...500kHz	99dB(μV) Qpk	500kHz...30MHz	93dB(μV) Qpk																																													
		Test	Norm	Port	Frequency	Limits																																																																
Radiated emissions	IEC55016	Case	30MHz...230MHz	40dB(μV/m) Qpk at 10m																																																																		
			230MHz...1GHz	47dB(μV/m) Qpk at 10m																																																																		
			1...3GHz	Do not apply																																																																		
			3...6GHz	Internal freq. < 108MHz																																																																		
Conducted emissions	IEC55016	Output	150kHz...500kHz	99dB(μV) Qpk																																																																		
			500kHz...30MHz	93dB(μV) Qpk																																																																		
<table border="1"> <thead> <tr> <th>Test</th> <th>Norm</th> <th>Port</th> <th>Severity</th> <th>Conditions</th> <th>P</th> </tr> </thead> <tbody> <tr> <td rowspan="2">Electrostatic discharge</td> <td rowspan="2">IEC61000-4-2</td> <td rowspan="2">Case</td> <td>±8kV</td> <td>Air (isolated parts)</td> <td rowspan="2">B</td> </tr> <tr> <td>±8kV</td> <td>Contact (conductive parts)</td> </tr> <tr> <td rowspan="4">Radiated high-frequency</td> <td rowspan="4">IEC61000-4-3</td> <td rowspan="4">X/Y/Z Axis</td> <td>20V/m</td> <td>0.08...1.0GHz M. 80% 1kHz</td> <td rowspan="4">A</td> </tr> <tr> <td>10V/m</td> <td>1.4...2.1GHz M. 80% 1kHz</td> </tr> <tr> <td>5V/m</td> <td>2.1...2.5GHz M. 80% 1kHz</td> </tr> <tr> <td>3V/m</td> <td>5.1...6GHz M. 80% 1kHz</td> </tr> <tr> <td rowspan="4">Fast transients</td> <td rowspan="4">IEC61000-4-4</td> <td>Input</td> <td>±2kV</td> <td rowspan="4">Tr/Th: 5/50 ns</td> <td rowspan="4">A</td> </tr> <tr> <td>Output</td> <td>±2kV</td> </tr> <tr> <td>Signal</td> <td>±2kV</td> </tr> <tr> <td>P</td> <td>±1kV</td> </tr> <tr> <td rowspan="2">Surge</td> <td rowspan="2">IEC61000-4-5</td> <td>Input L to L</td> <td>±1kV</td> <td rowspan="2">Tr/Th: 1.2/50μs</td> <td rowspan="2">B</td> </tr> <tr> <td>Input L to P</td> <td>±2kV</td> </tr> <tr> <td rowspan="4">Conducted RF</td> <td rowspan="4">IEC61000-4-6</td> <td>Input</td> <td>10V</td> <td rowspan="4">0.15...80MHz M. 80% 1kHz</td> <td rowspan="4">A</td> </tr> <tr> <td>Output</td> <td>10V</td> </tr> <tr> <td>Signal</td> <td>10V</td> </tr> <tr> <td>P</td> <td>10V</td> </tr> <tr> <td>Magnetic field</td> <td>IEC61000-4-8</td> <td>X/Y/Z Axis</td> <td>300A/m</td> <td>0Hz, 16.7Hz, 50/60Hz</td> <td>A</td> </tr> <tr> <td>Pulse magnetic field</td> <td>IEC61000-4-9</td> <td>X/Y/Z Axis</td> <td>300A/m</td> <td>Tr/Th: 6.4/16μs</td> <td>B</td> </tr> </tbody> </table>	Test	Norm	Port	Severity	Conditions	P	Electrostatic discharge	IEC61000-4-2	Case	±8kV	Air (isolated parts)	B	±8kV	Contact (conductive parts)	Radiated high-frequency	IEC61000-4-3	X/Y/Z Axis	20V/m	0.08...1.0GHz M. 80% 1kHz	A	10V/m	1.4...2.1GHz M. 80% 1kHz	5V/m	2.1...2.5GHz M. 80% 1kHz	3V/m	5.1...6GHz M. 80% 1kHz	Fast transients	IEC61000-4-4	Input	±2kV	Tr/Th: 5/50 ns	A	Output	±2kV	Signal	±2kV	P	±1kV	Surge	IEC61000-4-5	Input L to L	±1kV	Tr/Th: 1.2/50μs	B	Input L to P	±2kV	Conducted RF	IEC61000-4-6	Input	10V	0.15...80MHz M. 80% 1kHz	A	Output	10V	Signal	10V	P	10V	Magnetic field	IEC61000-4-8	X/Y/Z Axis	300A/m	0Hz, 16.7Hz, 50/60Hz	A	Pulse magnetic field	IEC61000-4-9	X/Y/Z Axis	300A/m	Tr/Th: 6.4/16μs	B
Test	Norm	Port	Severity	Conditions	P																																																																	
Electrostatic discharge	IEC61000-4-2	Case	±8kV	Air (isolated parts)	B																																																																	
			±8kV	Contact (conductive parts)																																																																		
Radiated high-frequency	IEC61000-4-3	X/Y/Z Axis	20V/m	0.08...1.0GHz M. 80% 1kHz	A																																																																	
			10V/m	1.4...2.1GHz M. 80% 1kHz																																																																		
			5V/m	2.1...2.5GHz M. 80% 1kHz																																																																		
			3V/m	5.1...6GHz M. 80% 1kHz																																																																		
Fast transients	IEC61000-4-4	Input	±2kV	Tr/Th: 5/50 ns	A																																																																	
		Output	±2kV																																																																			
		Signal	±2kV																																																																			
		P	±1kV																																																																			
Surge	IEC61000-4-5	Input L to L	±1kV	Tr/Th: 1.2/50μs	B																																																																	
		Input L to P	±2kV																																																																			
Conducted RF	IEC61000-4-6	Input	10V	0.15...80MHz M. 80% 1kHz	A																																																																	
		Output	10V																																																																			
		Signal	10V																																																																			
		P	10V																																																																			
Magnetic field	IEC61000-4-8	X/Y/Z Axis	300A/m	0Hz, 16.7Hz, 50/60Hz	A																																																																	
Pulse magnetic field	IEC61000-4-9	X/Y/Z Axis	300A/m	Tr/Th: 6.4/16μs	B																																																																	
P= Performance criteria, L= Line, P= PE (Protective Earth)																																																																						
4.3.7	Relative humidity	Up to 95%																																																																				
5.1.1.2	DC power supply range	From 0.70 to 1.25 Un continuous																																																																				
5.1.1.3	Temporary DC power supply fluctuation	From 0.60 to 1.40 Un 0.1s From 1.25 to 1.40 Un 1s without damage																																																																				
5.1.1.4	Interruptions of voltage supply	Class S2 (10ms)																																																																				
5.1.1.6	Input ripple factor	10% peak to peak with a DC Ripple Factor of 5 %																																																																				
5.1.3	Supply change-over	0,6 Un duration 100 ms (without interruptions). Performance criterion A																																																																				
7.2.7	Input reverse polarity protection	By serial diode in the input																																																																				
10.7	Protective coating for PCB assemblies	Class PC2																																																																				
13.3	Tests list	<table border="1"> <tbody> <tr><td>1 Visual Inspection</td><td>Routine</td></tr> <tr><td>2 Performance test</td><td>Routine</td></tr> <tr><td>3 Power supply test</td><td>Routine</td></tr> <tr><td>4 Insulation test</td><td>Routine</td></tr> <tr><td>5 Low temperature storage test</td><td>-</td></tr> <tr><td>6 Low temperature start-up test</td><td>Type</td></tr> <tr><td>7 Dry heat test</td><td>Type</td></tr> <tr><td>8 Cyclic damp heat test</td><td>Type</td></tr> <tr><td>9 Salt mist test</td><td>-</td></tr> <tr><td>10 Enclosure protection test (IP code)</td><td>-</td></tr> <tr><td>11 EMC test</td><td>Type</td></tr> <tr><td>12 Shocks and vibrations test</td><td>Type</td></tr> <tr><td>13 Equipment stress screening test</td><td>Routine: 24h at 40°C and load 100%</td></tr> <tr><td>14 Rapid Temperature variation test</td><td>Type</td></tr> </tbody> </table>	1 Visual Inspection	Routine	2 Performance test	Routine	3 Power supply test	Routine	4 Insulation test	Routine	5 Low temperature storage test	-	6 Low temperature start-up test	Type	7 Dry heat test	Type	8 Cyclic damp heat test	Type	9 Salt mist test	-	10 Enclosure protection test (IP code)	-	11 EMC test	Type	12 Shocks and vibrations test	Type	13 Equipment stress screening test	Routine: 24h at 40°C and load 100%	14 Rapid Temperature variation test	Type																																								
1 Visual Inspection	Routine																																																																					
2 Performance test	Routine																																																																					
3 Power supply test	Routine																																																																					
4 Insulation test	Routine																																																																					
5 Low temperature storage test	-																																																																					
6 Low temperature start-up test	Type																																																																					
7 Dry heat test	Type																																																																					
8 Cyclic damp heat test	Type																																																																					
9 Salt mist test	-																																																																					
10 Enclosure protection test (IP code)	-																																																																					
11 EMC test	Type																																																																					
12 Shocks and vibrations test	Type																																																																					
13 Equipment stress screening test	Routine: 24h at 40°C and load 100%																																																																					
14 Rapid Temperature variation test	Type																																																																					

